

ANALYSIS AND TESTING OF HEAT EXCHANGER FOR AN ENVIRONMENTALLY FRIENDLY RDF DRYING MACHINE

by Budhi Suyitno

Submission date: 02-Sep-2020 05:52AM (UTC+0700)

Submission ID: 1377864142

File name: B1_1.pdf (881.8K)

Word count: 3380

Character count: 15162

ANALYSIS AND TESTING OF HEAT EXCHANGER FOR AN ENVIRONMENTALLY FRIENDLY RDF DRYING MACHINE

LA ODE MOHAMMAD FIRMAN, EKA MAULANA, AGRI SUWANDI,
DWI RAHMALINA & BUDHI M. SUYITNO

Center of Excellence in New and Renewable Energy, Magister of Mechanical Engineering,
Faculty of Engineering, University of Pancasila, Jakarta, Indonesia

ABSTRACT

Refuse Derived Fuel (RDF) is used as a solid fuel on pyrolysis, but it still possesses a relatively high humidity; therefore, it needs to be dried in a RDF drying machine with a temperature of 60°C (Daud Heru, 2018). One crucial component in a RDF drying machine is the Heat Exchanger device. To learn more about the heat transfer rate, its physical dimensions, and the number of inlets and outlets (channels) in a heat exchanger, it is necessary to conduct a laboratory study. The objectives of this study are to analyze a heat exchanger, and its effectiveness, carry out an analysis on air temperature and heat transfer rate, and last but not the least, to test a flat plate heat exchanger. The construction work, analysis, and the testing of a flat plate heat exchanger mentioned above were carried out in the early 2018 until 2019 at the Laboratory of the Faculty of Engineering, Universitas Pancasila, Jakarta, Indonesia. The results of the study show that the flat plate heat exchanger is better than shell and tube heat exchange, and the heat transfer rate and air temperature from the environment will increase quite well after air passes a flat plate heat exchanger. Air temperature exiting from a flat plate heat exchanger will rise up to 83.3°C, whereas air temperature in the drying chamber has to be maintained at the required temperature for drying RDF, which is 60°C. The flow rate of the fluid mass and temperature differences in a flat plate heat exchanger will have a bearing on its effectiveness.

KEYWORDS: Analysis, Testing & Flat Plate Heat Exchanger

Received: Nov 02, 2019; Accepted: Nov 22, 2019; Published: May 08, 2020; Paper Id.: IJMPERDJUN202041

1. INTRODUCTION

1.1 Background

The process of analysis and testing a heat exchanger device, which is used in an Refuse Derived Fuel (RDF) drying machine, needs to take into account the heat transfer mechanism that occurs within the dryer. Therefore, it is essential that we carry out a heat transfer analysis prior to constructing such a device, wherein the heat transfer process, the physical dimensions, and the number of inlets and outlets in the heat exchanger are crucial aspects of the analysis. To learn more about the changes in air temperature, the heat transfer rate, and the effectiveness of the device that will be used in a RDF drying machine, it is necessary to carry out a laboratory study. It might be preferable, if the fuel used to increase air temperature in the drying chamber is associated with renewable energy; therefore, we will be using the RDF. Refuse Derived Fuel is used as solid fuel on pyrolysis, but it still possesses a relatively high humidity; consequently, it needs to be dried in an RDF drying machine. The dried RDF is placed in the burning chamber and will be used as fuel; meanwhile, the still relatively humid RDF will be placed in the drying chamber to get it dried by the heat exiting from the heat exchanger. The desired air temperature for drying RDF in the drying chamber is 60°C (Daud Heru, 2018). A heat exchanger is a crucial component in a drying machine, and

its role is to increase air temperature as needed to match the requirement for drying *RDF* in the drying chamber. To find out the effectiveness of a heat exchanger device, the degree of air temperature as well as the device's heat transfer rate, we need to carry out a study on the analysis and to carry out the necessary analysis to test the heat exchanger device in a laboratory. That way, air temperature and the heat transfer rate from the heat exchanger can be adjusted to match the desired temperature for drying *RDF* in the drying chamber.

1.2 Research Objectives

The objectives of the research are as follows:

- To prove that flat plate heat exchanger (HE) is better than shell and tube heat exchanger;
- To analyze the effectiveness of a flat plate heat exchanger, which will be used in an environmentally friendly *RDF* drying machine;
- To analyze the temperature and heat transfer rate, and adjust its air temperature in the drying chamber that reaches the desired temperature of 60°C;
- Last but not least, to carry out a test on the flat plate heat exchanger.

1.3 Method

The analysis process, testing and associated analysis were carried out at the Laboratory of the Faculty of Engineering, Universitas Pancasila in Jakarta. The construction and testing of the heat exchanger device have been carried out in the early 2018 until 2019 at the Laboratory of the Faculty of Engineering, Universitas Pancasila in Jakarta, Indonesia.

2. RESULTS AND DISCUSSIONS

In general, fuel can be classified into the following, solid fuel, liquid fuel, gas fuel, and nuclear fuel. A drying machine commonly uses solid fuel; however, some of them may also use gas stove, which is placed below the heat exchanger, as illustrated in the figure 1 below:

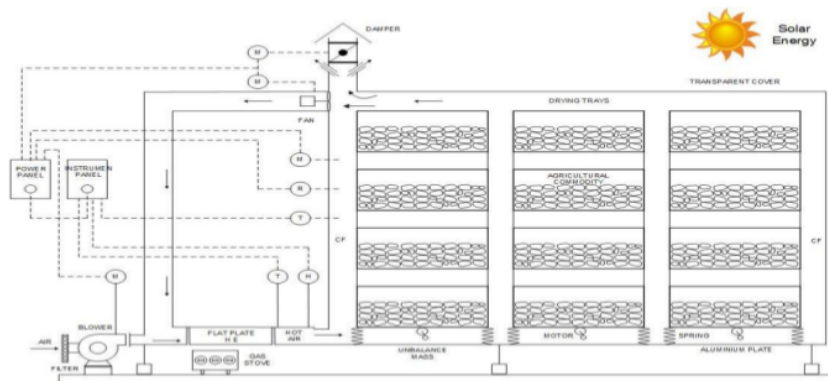

Figure 1: An Environmentally Friendly Drying Machine that uses Vibration Components and Gas Fuel.

T: Temperature
M: Electrical Motor
H: Humidity

The Log Mean Temperature Difference (LMTD) method would be used to analyze heat transfer on a heat exchanger device, if the entry and exit temperatures were known or if they could be determined easily; therefore, the LMTD value could be calculated without difficulty. However, if the entry and exit temperatures were not known, it would be easier to carry out the analysis using the heat exchanger effectiveness method. Heat exchanger effectiveness is defined as the ratio of the actual heat transfer and the maximum heat transfer value that may occur. Heat exchanger is needed to increase temperature in the drying machine until 60 °C, and the outlet temperature from heat exchanger is 83.3 °C.

2.1 Analysis of Flat Plate Heat Exchanger

- Length of air duct, $L_d = 40$ cm;
- Width of heat exchanger, $L_{apk} = 60$ cm;
- Length of gas duct, $L_p = 30$ cm;
- Air passage, $n_p = 11$ and gas passage, $n_d = 12$;
- Width of gas duct, $b_p = 3$ cm and width of air duct, $b_d = 2$ cm;
- The required air velocity, $V_d = 2.9$ m/s and air temperature entering to heat exchanger, $T_d = 30$ °C;
- The hot gas are available at temperature, $T_p = 300$ °C and at velocity, $V_p = 0.3$ m/s;
- Wetted perimeter on gas side, $P_p = 3+40+3+40 = 86$ cm = 0.86 m;

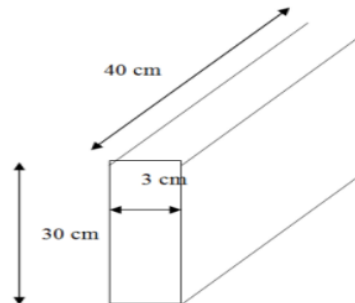

Figure 2: Passage of Hot Gas on Flat Plate Heat Exchanger.

Wetted perimeter on air side, $P_d = 30 + 2 + 30 + 2 = 64$ cm = 0.64 m.

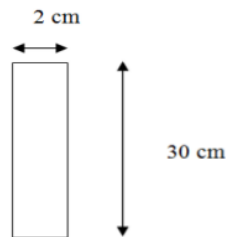

Figure 3: Passage of Cold Air on Flat Plate Heat Exchanger.

- Cross sectional area of gas passage (per passage), $A_p = 3$ cm x 30 cm = 90 cm² = 0.009 m² and $A_{p_{tot}} = 0.009 \times 11 = 0.099$ m²;

- Cross sectional area of air passage (per passage), $A_d = 2 \text{ cm} \cdot 40 \text{ cm} = 80 \text{ cm}^2 = 0.008 \text{ m}^2$ and $A_{d_{\text{tot}}} = 0.008 \times 12 = 0.096 \text{ m}^2$;
- Hydraulic diameter of air duct, $DH_d = (4 A_d) / P_d = (4 \times 80 \text{ cm}^2) / 64 \text{ cm} = 5 \text{ cm} = 0.05 \text{ m}$;
- Hydraulic diameter of gas duct, $DH_p = (4 \times 90 \text{ cm}^2) / 86 \text{ cm} = 4.19 = 0.0419 \text{ m}$;
- Heat transfer surface area, $A_{\text{total}} = [(40 \times 30) + (40 \times 30)] \cdot 11 = 2640 \text{ cm}^2 = 0.2640 \text{ m}^2$;
- The temperature of both fluids vary along the duct. It is therefore necessary to estimate an average temperature and refine the calculations after the outlet temperatures have been found. Selecting the average cold air temperature at $56.7 \text{ }^\circ\text{C} = 330 \text{ K}$, and base on this cold air temperature will be found: $\rho = 1.15 \text{ kg} / \text{m}^3$, $c_p = 1075 \text{ J/kg K}$, $k = 0.02780 \text{ W/m K}$, $\mu = 1.95 \times 10^{-5} \text{ kg} / \text{m s}$, $Pr = 0.70$. Selecting the average hot gas temperature at $247 \text{ }^\circ\text{C}$, and base on this cold air temperature will be found: $\rho = 0.840$, $c_p = 1017 \text{ J/kg K}$, $k = 0.0348 \text{ W/m K}$, $\mu = 2.36 \times 10^{-5}$, $Pr = 0.69$;
- The cold air available at rate, $m_d = \rho A V_d = 1.15 \times 0.008 \times 2.9 = 0.02668 \text{ kg/s}$, and $m_{d_{\text{total}}} = 0.02668 \times 12 = 0.32 \text{ kg/s}$;
- The hot gases available at rate, $m_p = 0.840 \times 0.009 \times 1.4 = 0.01058 \text{ kg} / \text{s}$, and $m_{p_{\text{total}}} = 0.01058 \times 11 = 0.12 \text{ kg/s}$;
- The mass rates perunit area, $m_d/A_{d_{\text{tot}}} = 0.32/0.096 = 3.33 \text{ kg} / \text{s m}^2$ and $m_p/A_{p_{\text{total}}} = 0.12 / 0.099 = 1.21 \text{ kg/s m}^2$;

Reynolds Number

$$Re_d = \frac{(m_d / A) DH_d}{\mu} = \frac{(0.32 / 0.096) 0.05}{1.95 \times 10^{-5}} = 8538.5$$

$$Re_p = \frac{(m_p / A) DH_p}{\mu} = \frac{(0.12 / 0.099) 0.0419}{2.36 \times 10^{-5}} = 2148.3;$$

They are Laminar flow.

The average unit conductances are:

$$hd = \left[(0.023) \left(\frac{kd}{DH_d} \right) (Re^{0.8} Pr^{0.33}) \right] \left[1 + \left(\frac{DH_d}{L_d} \right)^{0.7} \right]$$

$$hd = \left[(0.023) \left(\frac{0.02780}{0.05} \right) (8538.5^{0.8} \times 0.70^{0.33}) \right] \left[1 + \left(\frac{0.05}{0.4} \right)^{0.7} \right]$$

$$= 1.97$$

$$hp = \left[(0.023) \left(\frac{kp}{DH_p} \right) (Re^{0.8} Pr^{0.33}) \right] \left[1 + \left(\frac{DH_p}{L_p} \right)^{0.7} \right]$$

$$hp = \left[(0.023) \left(\frac{0.0348}{0.0419} \right) (2148.3)^{0.8} (0.69)^{0.33} \right] \left[1 + \left(\frac{0.0419}{0.3} \right)^{0.7} \right]$$

$$= 1.2$$

1 if the thermal resistance of the metal wall is neglected, the over all conductance is,

$$U A = \frac{1}{\frac{1}{hd \cdot A_{tot}} + \frac{1}{hp \cdot A_{tot}}} = \frac{1}{\frac{1}{1.97 \times 2.640} + \frac{1}{1.2 \times 2.640}}$$

$$= \frac{1}{\frac{1}{5.2} + \frac{1}{3.17}} = \frac{1}{0.19 + 0.32} = \frac{1}{0.51} = 1.96$$

1 The number of transfer units, based on the warmer fluid which has the smaller heat capacity rate,

$$NTU = \frac{U A}{C_{min}} = \frac{U A}{m_p c_p} = \frac{1.96}{0.0027 \cdot 1017} = \frac{1.96}{2.75} = 0.71;$$

The hourly heat capacity ratio,

$$\frac{C_{panas}}{C_{dingin}} = \frac{m_d c_{pp}}{m_p c_{pd}} = \frac{0.12 \times 1075}{0.32 \times 1017} = \frac{129}{325.44} = 0.4;$$

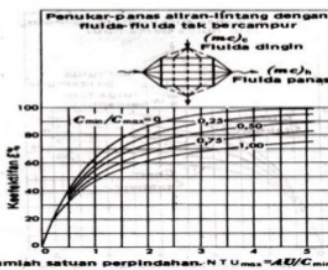

1 Figure 4: Heat-Exchanger Effectiveness for Crossflow with Both Fluids Unmixed.

1 From Figure 4, about heat exchanger effectiveness for cross flow with both fluids unmixed, the effectiveness is $\epsilon = 43\% = 0.43$;

1 Finally, the average outlet temperature of the air is

$$T_{d \text{ out}} = T_{d \text{ in}} + C_p/C_d (\epsilon) (\Delta T_{\text{max}})$$

$$= 30 \text{ }^\circ\text{C} + (0.56) (0.43) (300 - 30) = 95.02 \text{ }^\circ\text{C};$$

1 A check on the mean air temperature gives,

$$T_{mean} = \frac{Td_{in} + Td_{out}}{2}$$

$$= \frac{30 + 95.02}{2} = 62.51 \text{ } ^\circ\text{C}$$

Which is sufficiently close to the assumed value of 56.7 °C so as to make a second approximation unnecessary.

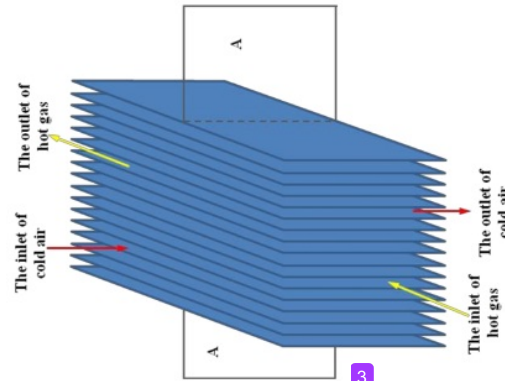

Figure 5: Passage of Hot Gas and Cold Air on Flat Plate Heat Exchanger.

Effectiveness of flat plate heat exchanger through testing,

$$C_p = \frac{m_d \cdot c_{p_d} \cdot \Delta T_d}{m_p \cdot c_{p_p} \cdot \Delta T_{max}}$$

$$C_p = \frac{0.42 \times 1.008 \cdot (82.6 - 34.6)}{0.22 \times 1.008 \cdot (300 - 34.6)} = 0.345 = 34.5 \%$$

In the afternoon, temperature of testing is $T_{d_{out}} = 82.6 \text{ } ^\circ\text{C}$ and $T_{d_{in}} = 34.6 \text{ } ^\circ\text{C}$. These are almost the same as temperature of analysis, namely $T_{d_{out}} = 95.02 \text{ } ^\circ\text{C}$ and $T_{d_{in}} = 30 \text{ } ^\circ\text{C}$.

2.2 Analysis of Shell and Tube Heat Exchanger

In order to increase the effective heat transfer surface area per unit volume, most commercial heat exchangers provide for more than a single pass through the tubes, and the fluid flowing outside the tubes in the shell is routed back and forth by means of baffles.

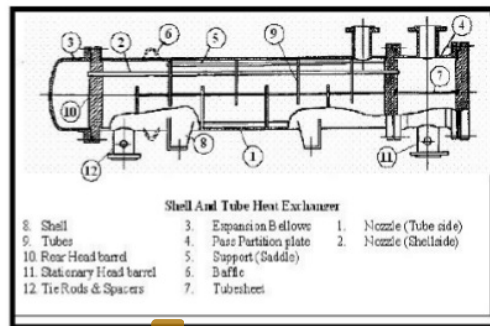

Figure 6: Shell and Tube Heat Exchanger.

The average outlet temperature of the hot gas on flat plate heat exchanger is 247 °C.

The outlet temperature of the hot gas on shell and tube heat exchanger is $T_{p_{out}} = 194$ °C. The hot gas are available at a temperature of 300 °C and the cold air are available at a temperature of 28 °C.

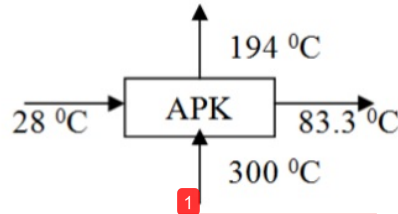

Figure 7: Temperature on Shell and Tube Heat Exchanger.

The logarithmic mean overall temperature difference for cross flow with one tube pass and one shell pass,

$$LMTD = \frac{\Delta T_{max} - \Delta T_{min}}{\ln \left(\frac{\Delta T_{max}}{\Delta T_{min}} \right)}$$

$$LMTD = \frac{(300 - 83,3) - (194 - 28)}{\ln \left[\frac{300 - 83,3}{194 - 28} \right]} = \frac{50,6}{\ln (1,3)} = 194,6 \text{ } ^\circ\text{C}$$

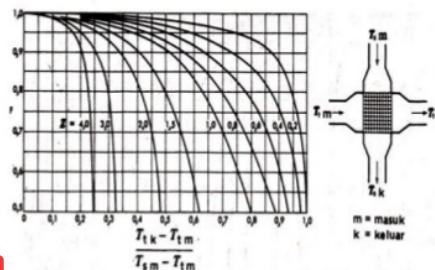
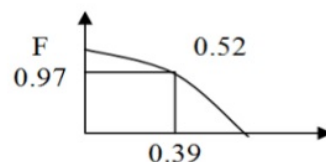

Figure 8: Correction Factor to Counterflow LMTD for Crossflow Heat Exchanger, Both Fluids Unmixed, One Tube Pass.

For the cross flow arrangement, the appropriate mean temperature difference by applying the correction factor found from figure 8 to the mean temperature for cross flow,

$$P = \frac{194,1 - 300}{28 - 300} = 0,39 = 0,39 \text{ and } R = \frac{28 - 83,3}{194,1 - 300} = 0,52$$



Based on figure 10 found the correction factor, $F = 0.97$.

The rate of heat transfer is,

$$q_{APK} = U A F \Delta T_m = 23.3 \text{ kJ/s}$$

Total of heat transfer surface area is,

$$A = \frac{q_{APK}}{U F \Delta T_m}$$

$$\frac{23.3 \times 10^3 \text{ W}}{50 \times 0.97 \times 194.6} = 2.5 \text{ m}^2$$

The length of tube is, $L = 30 \text{ cm} = 0.3 \text{ m}$

By using BWG 18 the diameter out of tube is,

$$d = 1 \frac{1}{4} \text{ in} = 3.18 \text{ cm}$$

$$= 0.032 \text{ m}$$

Total of tube is,

$$n = \frac{A}{2 \pi d L}$$

$$= \frac{2.5}{2 \times 3.14 \times 0.032 \times 0.3} = 41.6$$

$$= 42 \text{ pipes}$$

The rate of heat transfer on ¹² flat plate heat exchanger is, $q_{APK} = 23.3 \text{ kJ/s}$, and from design ⁴ flat plate heat exchanger found,

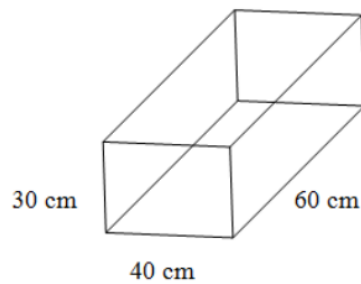

Diameter for shell and tube heat exchanger is,

$$D = \frac{4 A}{k \ell \ell}$$

$$= \frac{4 (40 \times 60)}{40 + 60 + 40 + 60}$$

= 48 cm

The rate of heat exchanger for flat plate heat exchanger is the same as shell and tube heat exchanger, $q_{APK} = 23.3$ kJ/s

Design results of shell and tube heat exchanger are,

- Total of tube, $n = 42$ for each passage;
- Diameter out of tube, $d = 1 \frac{1}{4}$ in = 0.032 m = 3.2 cm and pitch is 19/16 in = 3 cm;
- Length of tube in the shell and tube heat exchanger, $L = 30$ cm = 0.3 m;
- Diameter of shell, $D = 48$ cm = 18.9 in;

With the known fact that diameter of shell on shell and tube heat exchanger is 48 cm, this diameter will not be enough for 42 tubes because one tube on shell and tube heat exchanger needs diameter and pitch, $dp = 3.2 + 3$ cm = 6.2 cm or total of tubes on shell and tube heat exchanger need 260.4 cm., This research chooses flat plate heat exchanger as heat exchanger for an environmentally friendly *rdf* drying machine based on total of tube reason on shell and tube heat exchanger.

After the completion of the analysis process and testing, we learned that the flat plate heat exchanger was able to supply heat to the drying chamber, thus raising air temperature within the chamber to 60°C, and, we then moved ahead to test the flat plate heat exchanger. The physical dimension of the flat plate heat exchanger is 40 cm in length, 60 cm in width, and 30 cm in height, and it is constructed from aluminum plates where each of the plates is 1 mm thick. Aluminum plates are excellent heat conductors, and it is easy for them to maintain the heat and they are quite durable. A flat plate heat exchanger's dimension and the number of its inlets and outlets can be customized according to the need of its user. Eleven (11) outlets stream the heated gas from the burned *RDF*. Mean while, outside air that enters and exits the flat plate heat exchanger streams through twelve inlets. To obtain a temperature of 60°C in the *RDF* drying chamber, the exiting temperature from the flat plate heat exchanger needs to be at 83.3°C. The heat transfer rate of the tested flat plate heat exchanger is 23.3 kJ/s and its effectiveness is 34.5%. After drying, the *RDF* can be very well used for solid fuel on pyrolysis, because it possesses a relatively low humidity. The tested flat plate heat exchanger is placed on top of burning *RDF* fuel. Mean while, the gas produced by the burning is filtered through the components called cyclone and wet scrubber, which are positioned outside the burning chamber. It can be seen from the following figure:

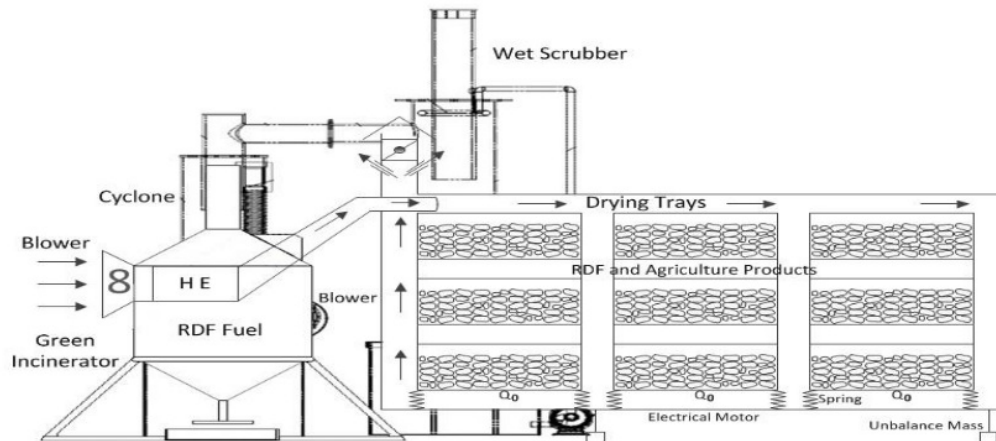

Figure 9: An Environmentally Friendly *RDF* Drying Machine that uses a Flat Plate Heat Exchanger and it is Fueled by *RDF*.



Figure 10: *RDF* Burning Chamber, Cyclone and Wet Scrubber.



Figure 11: A Flat Plate Heat Exchanger.

3. CONCLUSIONS

The results obtained from this study are summarized as follows:

- This environmentally friendly *RDF* drying machine is equipped with a flat plate heat exchanger with 11 outlets, which allow the heated gas produced by the burned fuel to exit the heat exchanger; meanwhile, air from the outside enters the system through 12 inlets; The heat exchanger itself is 40 cm in length, 60 cm in width, and 30 cm in height;
- Heat exchanger effectiveness of the tested device is 34.5%;

- Air temperature exiting the flat plate heat exchanger is 83.3°C; meanwhile, air temperature inside the drying chamber is maintained at 60°C;

REFERENCES

1. Daud Heru, "The effect of vibration toward charcoal briquette drying rate on tray dryer", Seminar Nasional Teknik Mesin, Politeknik Negri Jakarta, Proceeding Semnas Mesin, ISSN 2085-2762, Jakarta, 2018.
2. Jakkula, S. U. B. O. D. H., & Sharma, G. S. (2014). Analysis of a Cross Flow Heat Exchanger Using Optimization Techniques. *International Journal of Applied Engineering Research and Development (IJAERD)*, 4(6), 1-10.
3. Holman JP. 1989. *Heat Transfer*. McGraw Hill, New York.
4. Iynkaran K. 1993. *Basic Thermodynamics*. Singapore.
5. Veeresh, C., Varma, S. V. K., & Praveena, D. (2015). Heat and mass transfer in MHD free convection chemically reactive and radiative flow in a moving inclined porous plate with temperature dependent heat source and joule heating. *International Journal of Management, Information Technology and Engineering*, 3(11), 63-74.
6. Koestoeer RA. 2002. *Perpindahan Kalor (Heat Transfer)*. Salemba Teknika, Jakarta.
7. Sawant, S., More, S. E., & Dange, H. *Design, Development and Performance Analysis of Anticorrosive Heat Exchanger*.
8. Kreith F. 1998. *Principle of Heat Transfer*. Erlangga, Jakarta.
9. Nasrawi, H. K. R. *Natural Convection Heat Transfer Inside an Inclined Square Enclosure Filled with Al₂O₃ Nanofluid in Presence of Pair of Discrete Heat Flux Sources in Bottom Wall*.
10. Stoecker WF. 1989. *Design of Thermal Systems*. McGraw-Hill Ltd.



ANALYSIS AND TESTING OF HEAT EXCHANGER FOR AN ENVIRONMENTALLY FRIENDLY RDF DRYING MACHINE

ORIGINALITY REPORT

21%

SIMILARITY INDEX

18%

INTERNET SOURCES

7%

PUBLICATIONS

6%

STUDENT PAPERS

PRIMARY SOURCES

1

[archive.org](https://www.archive.org)

Internet Source

9%

2

Submitted to Universitas Mercu Buana

Student Paper

3%

3

Hector Bastida, Carlos E. Ugalde-Loo, Muditha Abeysekera, Xiandong Xu, Meysam Qardan.

"Dynamic Modelling and Control of Counter-Flow Heat Exchangers for Heating and Cooling Systems", 2019 54th International Universities Power Engineering Conference (UPEC), 2019

Publication

1%

4

calhoun.nps.edu

Internet Source

1%

5

www.tjprc.org

Internet Source

1%

6

www.arnjournals.org

Internet Source

1%

7

dosen.univpancasila.ac.id

1%

8 "Trends in Mechanical and Biomedical Design", Springer Science and Business Media LLC, 2021
Publication <1%

9 www.ukessays.com
Internet Source <1%

10 Submitted to Texas A&M University, College Station
Student Paper <1%

11 Submitted to University of Glamorgan
Student Paper <1%

12 journal.univpancasila.ac.id
Internet Source <1%

13 issuu.com
Internet Source <1%

14 peer.asee.org
Internet Source <1%

15 jmerd.org.my
Internet Source <1%

16 Kim, M.-H.. "Air-side performance of brazed aluminum heat exchangers under dehumidifying conditions", International Journal of Refrigeration, 200211 <1%

17 T.R. McClanahan, B.A. Cokos, E. Sala. "Algal growth and species composition under experimental control of herbivory, phosphorus and coral abundance in Glovers Reef, Belize", *Marine Pollution Bulletin*, 2002 <1%
Publication

18 "Numerical Simulation of Shell and Tube Heat Exchanger using Ansys Fluent", *International Journal of Innovative Technology and Exploring Engineering*, 2019 <1%
Publication

19 www.banyasz.hu <1%
Internet Source

20 hdl.handle.net <1%
Internet Source

Exclude quotes Off
Exclude bibliography On

Exclude matches Off